

OmniAC30CAPQ

Quick Start Guide

Version: 1.1

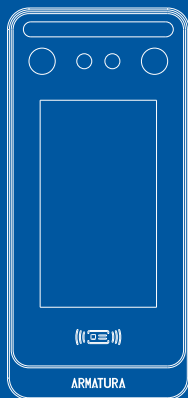

Overview

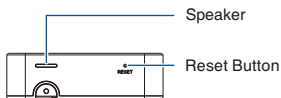
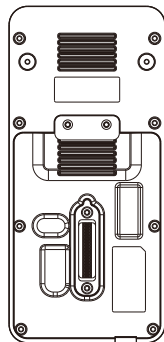
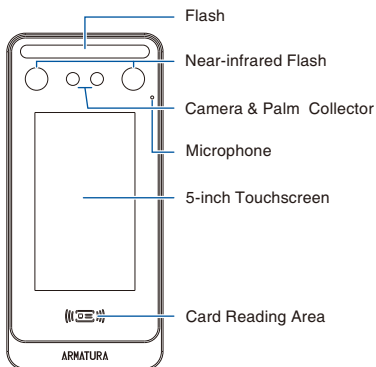

Terminal Block

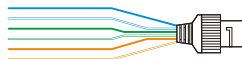
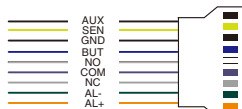
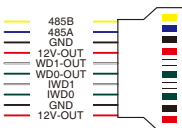
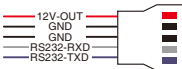
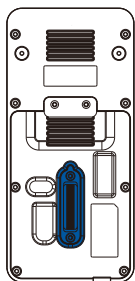

Installation Environment

Please refer to the following recommendations for installation.



KEEP DISTANCE



AVOID GLASS
REFRACTION



AVOID DIRECT
SUNLIGHT
AND EXPOSURE



KEEP EFFECTIVE
DISTANCE
0.3-2.5m

Recommended Palm Gestures

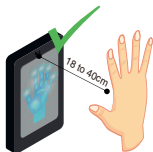

KEEP EFFECTIVE
DISTANCE OF
18 to 40cm



KEEP SPACES
BETWEEN
YOUR FINGERS



DO NOT KEEP
YOUR FINGERS
CLOSE



DO NOT KEEP
PALM OUTSIDE
COLLECTION AREA



DO NOT KEEP
YOUR FINGERS
FOLD/CURLED

Note:

1. Place your palm within 18 to 40 cm of the device.
2. Place your palm in the palm collection area, such that the palm is placed parallel to the device.
3. Make sure to keep space between your fingers.

Device Installation

● With Backplate ★:

1. Attach the mounting template sticker to the wall, and drill holes according to the mounting paper.
2. Fix the Backplate on the wall using wall mounting screws.
3. Attach the device to the Backplate.
4. Fasten the device to the Backplate with a security screw.

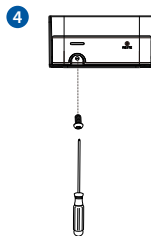
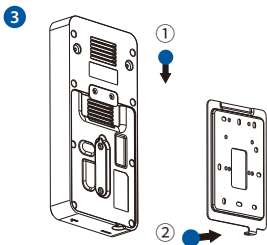
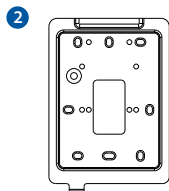
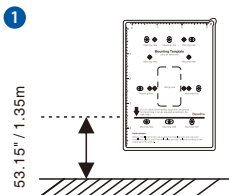

Note: Features and parameters with ★ mark are not available in all devices.

● With Back Cover:

1. Attach the mounting template sticker to the wall, and drill holes according to the mounting paper.
2. Fix the Back Cover on the wall using wall mounting screws.
3. Attach the device to the Back Cover.
4. Fasten the device to the Back Cover with a security screw.

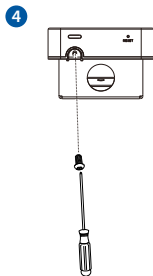
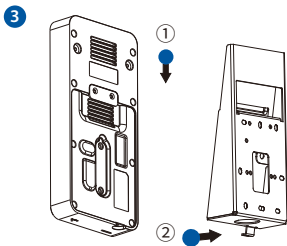
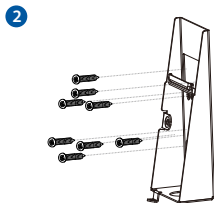
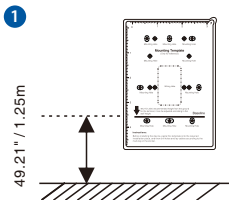

Standalone Installation

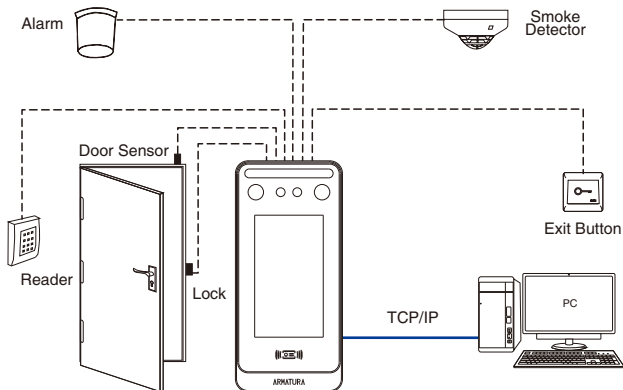

Power Connection

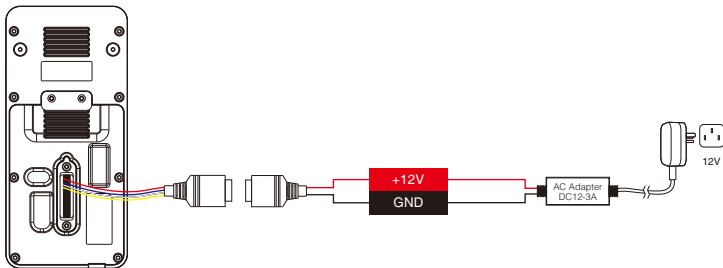

Recommended AC Adapter

1. $12V \pm 10\%$, at least 3000mA.
2. To share the power with other devices, use an AC Adapter with higher current ratings.

Ethernet Connection

Connect the device and computer software over an Ethernet cable. As shown in the example below:

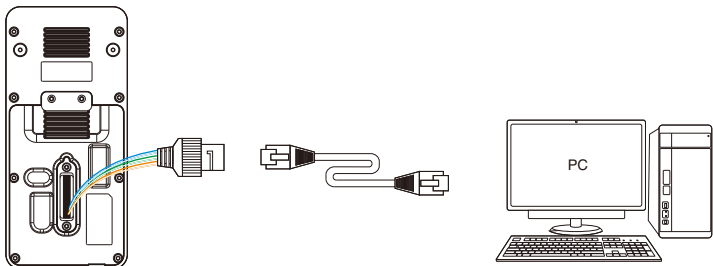

Default IP address: 192.168.1.201
Subnet mask: 255.255.255.0

IP address: 192.168.1.130
Subnet mask: 255.255.255.0

Click on [COMM.] > [Ethernet] > [IP Address] , input the IP address and click on [OK].

Note: In LAN, the IP addresses of the server (PC) and the device must be in the same network segment when connecting to the software.

Wiegand Reader and RS485 Connection

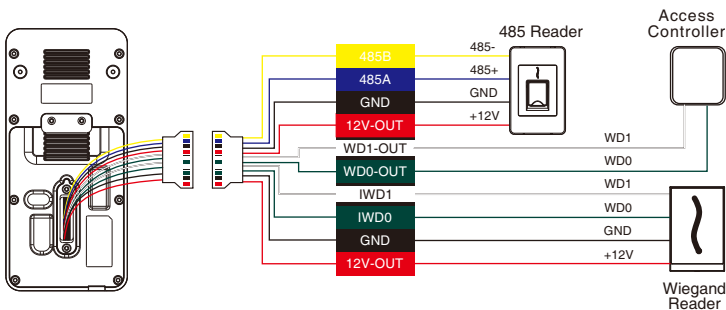

Printer Connection

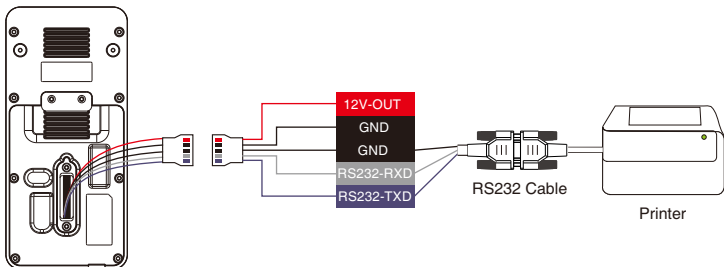

Door Sensor, Exit Button, Auxiliary Connection

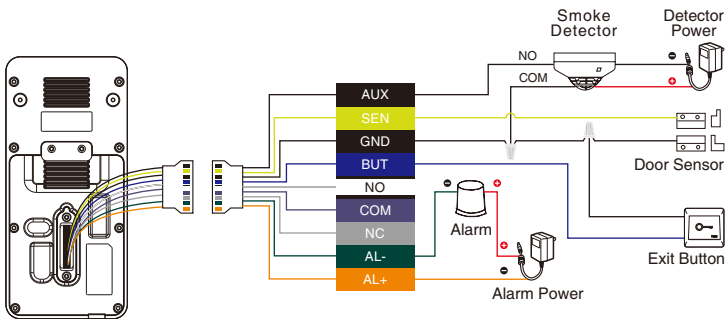

Lock Relay Connection

The system supports **Normally Opened Lock** and **Normally Closed Lock**. The **NO LOCK** (normally unlocked when power-on) is connected with 'NO' and 'COM' terminals, and the **NC LOCK** (normally locked when power-on) is connected with 'NC' and 'COM' terminals. Take NC Lock as an example below:

1) Device not sharing power with the lock

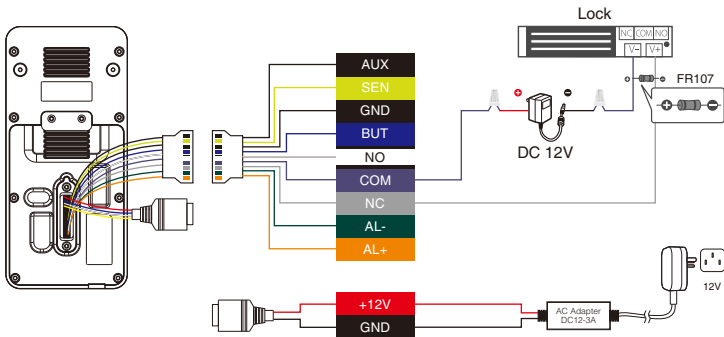

2) Device sharing power with the lock

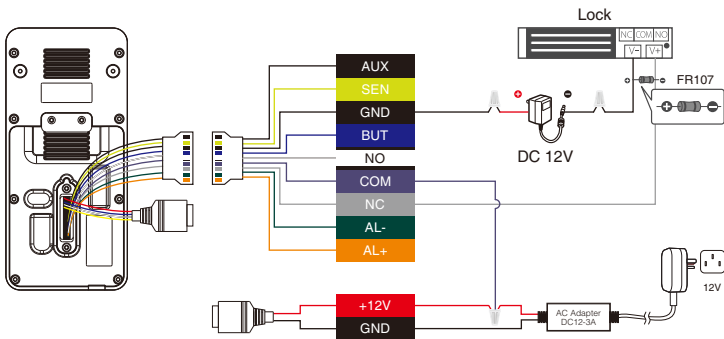

User Registration

When there is no super administrator set in the device, click on ☰ to enter the menu. Add a new user and set User Role to Super Admin, then the system requests for the administrator's verification before entering the menu. It is recommended to register a super administrator initially for security purposes.

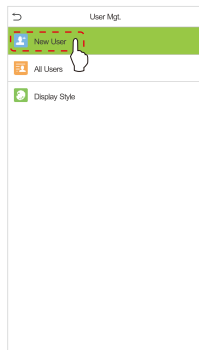
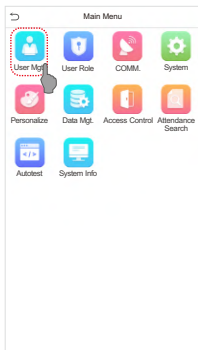
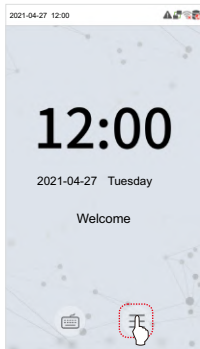

Click on ☰ > [User Mgt.] > [New User] to register a new user. The options include entering the user ID and Name, setting User Role, registering a Palm, Face, Card, Password and adding Profile Photo.





New User	
User ID	1
Name	Mike
User Role	Normal User
Palm	1
Face	1
Card	123456
Password	*****
Profile Photo	1
Access Control Role	



Ethernet and Cloud Server Settings

Click on  > [COMM.] > [Ethernet] to set the network parameters. If the TCP/IP communication of the device is successful, the icon  will be displayed in the upper right corner of the standby interface.

Click on  > [COMM.] > [Cloud Server Setting] to set the server address and server port, that is, the IP address and port number of the server after the software is installed. If the device communicates with the server successfully, the icon  will be displayed in the upper right corner of the standby interface.

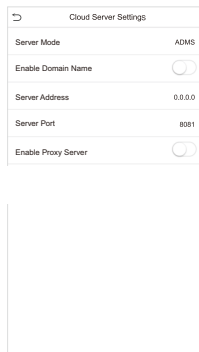
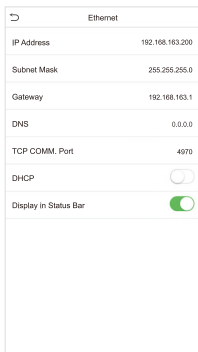
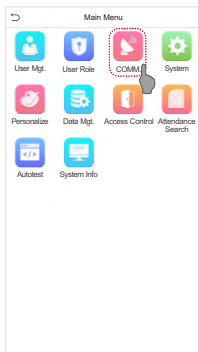

Access Control Settings

Click on ☰ > [Access Control] to enter the access control management interface and set relevant parameters of access control.

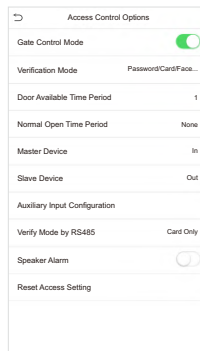
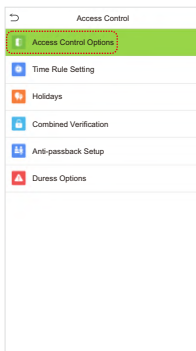
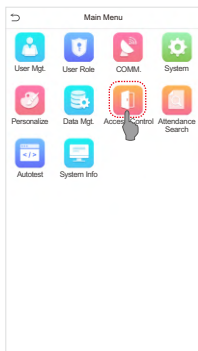

Records Query

Click on ☰ > [Attendance Search] > [Event Logs] to enter the records query interface, input the user ID and select the time range, the corresponding event logs will be displayed.

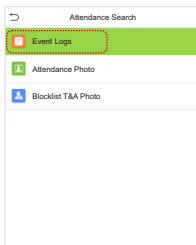
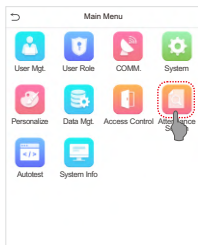

Personal Record Search

Date	User ID	Time
03-03		Number of Records:04
	4	11:25
	2	11:25 11:22
	3	11:25
03-04		Number of Records:04
	1	11:29
	3	11:29 11:21
	2	11:28
	4	11:26
03-05		Number of Records:04
	1	11:27
	4	11:27
	3	11:27
	2	11:27

Health Protection

Click on  > [System] > [Health Protection] to enable mask detection.

- 1 You can **Enable Mask Detection** function, and enable the **Deny Access Without Mask** and the **Trigger External Alarm**, the device will send an alarm prompt when the user doesn't wear a mask, meanwhile the user will be forbidden to access, as shown in the following figure.
- 2 When the **Allow Unregistered People to Access** is enabled, you can also set **Enable Capture of Unregistered Person** to save the user photo.

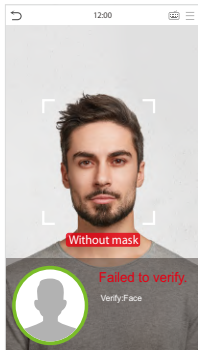
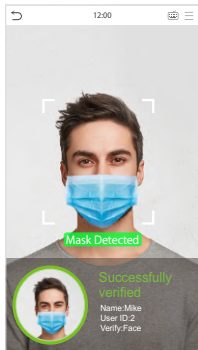
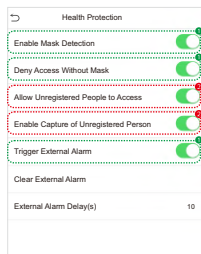
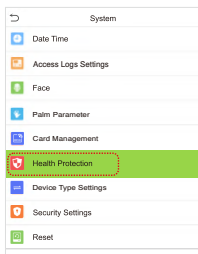
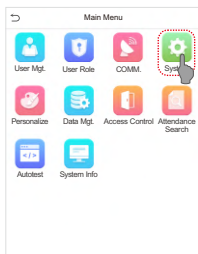



ARMATURA LLC www.armatura.us E-mail:sales@armatura.us
Copyright © 2022 ARMATURA LLC. All rights reserved.